

VW1 Quick Start Guide

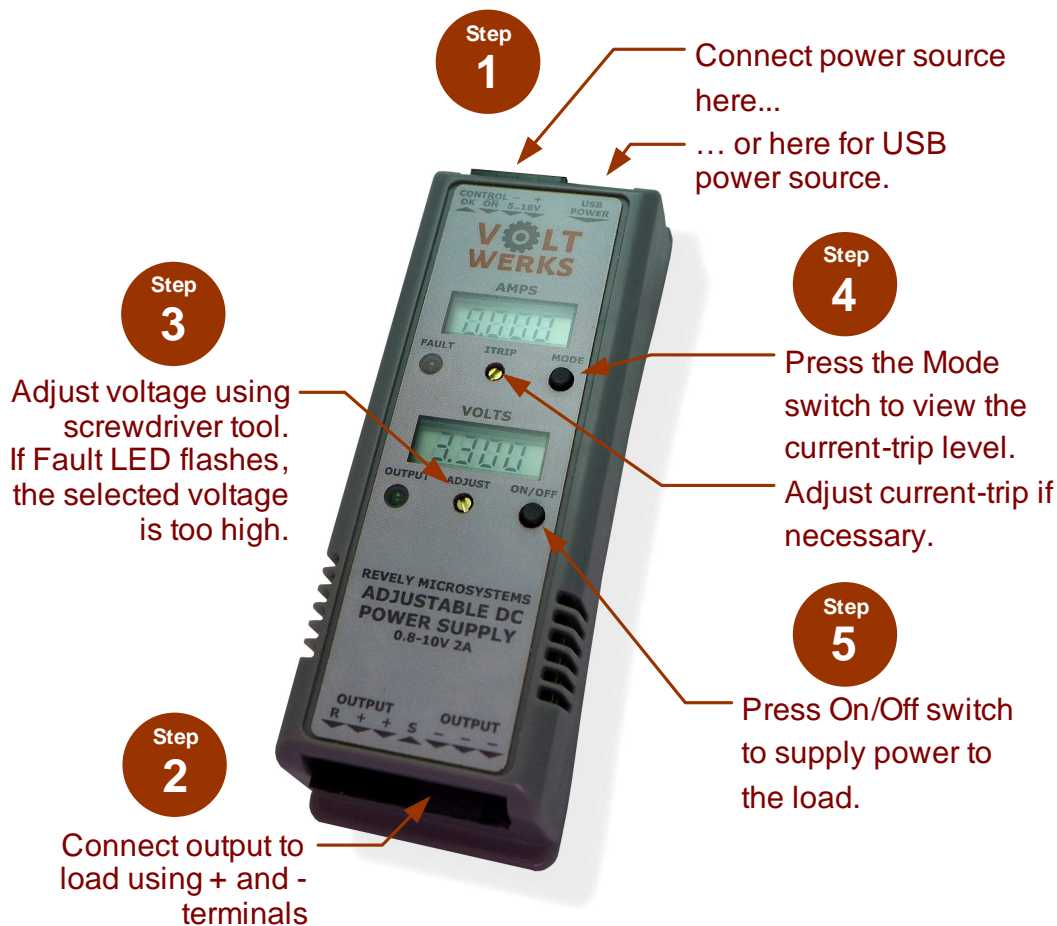

Faults are indicated by a flashing fault LED. The most common fault is when the output voltage is set too close or above the input voltage. Simply adjust the output voltage to correct this.

IFL _t	UFL _t	tFL _t	RFL _t	LFL _t	bFL _t	OFL _t
Current Trip Fault	Voltage Range Fault	Over-temperature	Regulation Fault	Load Fault	MCU Brown-out	Input over-voltage

WARNING: When using the 5..16V input terminals to supply power, do not connect a USB cable. The supply voltage present on the USB connector may exceed 5V and may damage any connected USB device or power supply.

WARNING: Do not exceed the current (amp) rating of a USB port when powering the VW1 power supply. Set the VW1 current trip to a value no higher than the capability of the power source. Most USB ports are protected against over-current, but this should not be assumed.

CAUTION: The aluminum surface on the back of the VW1 power-supply will get hot under some load conditions. Take care when handling the power supply.

VW1 User's Manual

This manual contains detail information on the operation and specifications of the VoltWerks VW1 power supply. The VW1 linear supply provides adjustable DC power for lab and system use. The 25 turn trimmers enable accurate and dependable voltage and current adjustment.

Overview



Linear Operation

The linear regulator provides very low noise output voltage. Linear operation does mean that the power supply must dissipated heat to maintain regulation. The maximum output current may be limited by the thermal capacity of the supply. See output current section for additional information.

Feature Summary

The VW1 linear supply provides adjustable DC power for lab and system use. Unlike most lab power supplies, VoltWerks has no clunky knobs. Precision trimmers and a fast current trip keep accurate power available at the point of load.

Simple and dependable operation

- Connect to included power supply or USB port
- Adjust output voltage with screwdriver
- Press ON switch to enable output

Applications

- Industry and University lab use
- Low-voltage digital circuit development and testing
- Analog circuit characterization
- Robotics, transportation, and automotive
- Burn-in and cycle testing

Features

Voltage Output

- 0.8 - 4.5V output with 5V or USB-style supply
- 0.8 - 10V output with 12V source
- 5mV voltage precision, noise less than 2mVPP

Current output

- 500mA output from powered USB port
- Up to 1–2 A from other power sources
- Adjustable current-trip

Other

- 4-digit LCD voltage and current meters
- Built-in thermal, voltage and current shutdown
- Push-on/off power button
- Digital control via Power Good Output and Enable Input
- Small 107x36x23mm size (4.21" x 1.43" x 0.91")
- Screw holes and DIN rail option

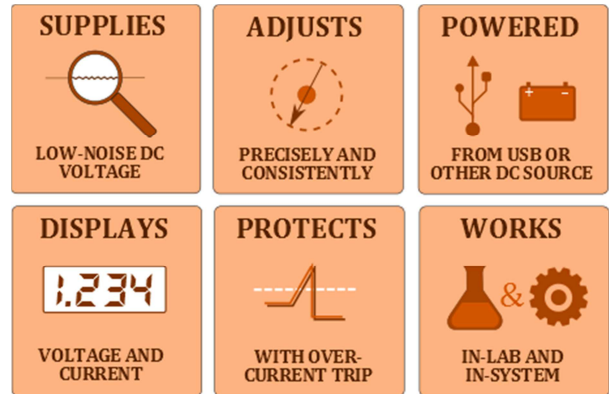

Part Numbers and Contents

Orderable Part Number	Power Source Included	Output capability using included power source
VW-M1-U	24AWG USB cable	4.5V 500mA
VW-M1-5V	5V 2.0A AC adapter (USA plug)	4.5V 2.0A
VW-M1-12V-US	12V 1.0A AC adapter (USA plug)	10V 1A
VW-M1-12V-EU	12V 1.0A AC adapter (Europe plug)	10V 1A
VW-M1-12V-UK	12V 1.0A AC adapter (UK plug)	10V 1A

Each kit includes: VW1 Power supply, screwdriver adjustment tool, screw-terminal blocks, and output cables.

VW1 Block Diagram

Figure 1

VOLTWERKS VW1 BLOCK DIAGRAM

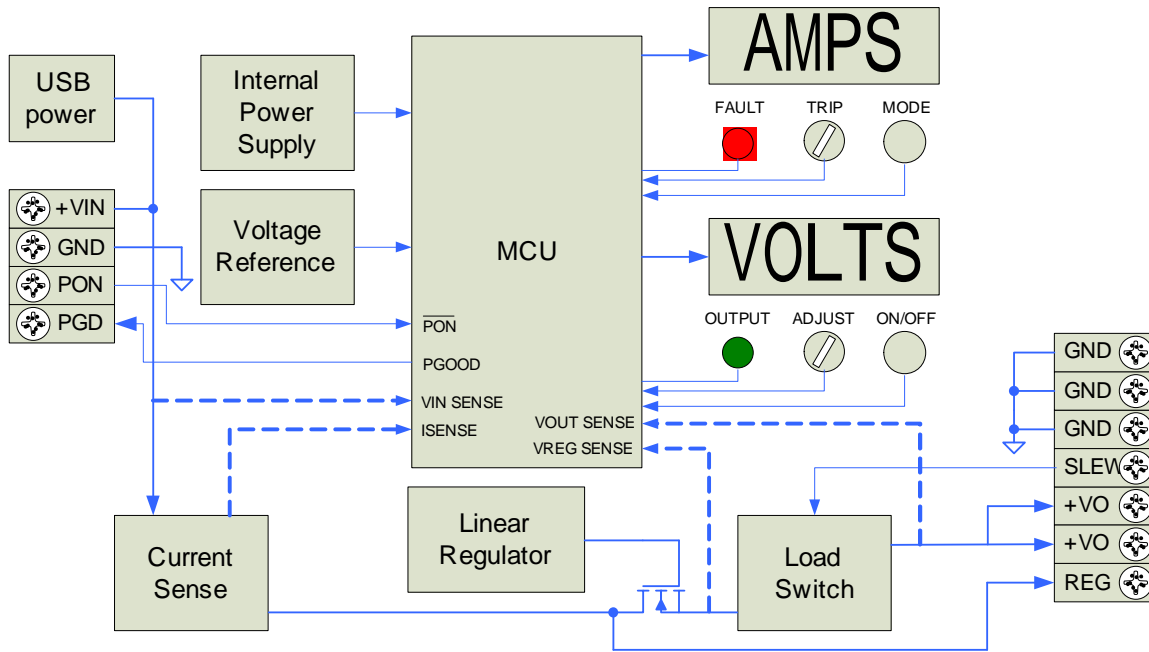

Indicators

VW1 displays voltage, current and status information on two LCD readouts and two LEDs.

Table 1 INDICATOR DESCRIPTIONS

Indicator Name	Description
Volts Display	Displays regulator voltage
Amps Display	This display has two primary modes. Output current mode: Displays load current Current trip level: Displays current trip limit (indicated by an 'L')
Output Indicator	Green LED illuminated when power output is active.
Fault Indicator	Red LED flashes when an error occurs.

Controls

The VW1 front panel includes two push-buttons and two 25-turn adjustment trimmers.

Control Name	Description
On/off button	Press to turn the power output on or off. Hold for 6 seconds to initiate a voltage calibration (see calibration section).
Mode button	Press to toggle between Amps display modes. Hold for 6 seconds to initiate a current calibration (see calibration section).
Voltage adjustment	Adjusts the regulator voltage.
Current trip adjustment	Adjusts the current trip from 0.01 – 2.2 Amps

Input/Control Terminals

A 4-way 3.5mm pluggable terminal block provides a power-source input as well as I/O signals for controlling and monitoring the VW1's output state. Replacement terminal block is Phoenix Contact 1840382 or equivalent.

Terminal Name	Description
OK	Power OK digital output. 1 = Output power is On, 0 = Output power is Off and/or there is a fault.
ON	Power ON digital input with internal pull-up resistor. 1 = On/Off button controls power. 0 = force power always On.
+ Input	Power input positive connection 5-16Vdc.
- Input	Power input ground connection.

WARNING: When using the input terminals to supply power, do not connect a USB cable. The supply voltage present on the USB connect may exceed 5V and may damage any connected USB device or power supply. The USB port cover should be glued in place to permanently protect against this.

Output Terminals

Output power is available through a 7-way 3.5mm pluggable terminal block. The terminal block also allows direct connection to the internal regulator and slew-rate configuration. Replacement terminal block is Phoenix Contact 1840418 or equivalent.

Terminal Name	Description
R	Direct connection to regulator output for bypassing output power switch. Leave unconnected in most applications.
+ Output	Power ON digital input with internal pull-up resistor. 1 = On/Off button controls power. 0 = force power always On.
+ Output	
S	Slew rate control input. Adjusts the turn-on slew rate using external capacitance. Leave unconnected in most applications.
- Output	Power Output ground connection.
- Output	
- Output	

Fault Conditions

Error Type	Description	Display	To clear
Current Trip	<p>Measured current exceeded set-point current. Output power is now off but regulated power is still available.</p> <p>Resolution: Press the Mode button to display current-limit value (XX.XL) and increase current trip point using the screwdriver tool.</p>	IFL t	Cleared when at next output power-on event.
Voltage Range fault	<p>Unable to guarantee regulation due to selected voltage ranges. Root issues are:</p> <ul style="list-style-type: none"> a) Input voltage is less than 4.5V b) Output voltage is too close to input voltage - less than 0.25V c) Output voltage too low (less than 0.70V). d) Output voltage is set too high (Greater than 11.5V) <p>Resolution: Adjust voltage trimmer to reduce output voltage and/or increase the supply voltage to VW1.</p>	UFL t	If output is off then cleared automatically, otherwise cleared at next power-on event.
Temperature fault	<p>VW1 reports internal temperature with heat-sink temperature exceeding 70degC.</p> <p>Resolution: Reduce the VW1 power dissipation by reducing load current, reducing supply voltage, and/or increasing output voltage.</p>	tFL t	Cleared at next output power-on event.
Loss of regulation	<p>Internal regulator reports loss of regulation. This fault can occur due to a severe over-current or when the input supply voltage glitches.</p> <p>Resolution: Improve supply power quality and/or remove fault on output terminals.</p>	RFL t	If output is off then cleared automatically, otherwise cleared at next power-on event.
Load fault	<p>Output voltage is more than 10mV from regulator output when output power switch is on. Can be due short-circuit, or other load fault.</p> <p>Resolution: Verify that load does not exceed VW1 ratings.</p>	LFL t	If output is off then cleared automatically, otherwise cleared at next power-on event.
Brown-out or internal fault	<p>The internal power rail has momentarily dropped too low. Can be caused by glitches in supply rail, low-battery (in battery powered systems).</p> <p>Resolution: Make sure that the supply voltage is always above 4.5V.</p>	bFL t	Cleared automatically when valid power is restored.
Over-voltage fault	<p>Over-voltage fault. Supply voltage limit exceeded so VW1 has shut-down the output to try to protect the load.</p> <p>Resolution: Reduce the supply voltage and verify that VW1 has not been damaged by the over-</p>	OFL t	Cleared when at next output power-on event.

voltage condition.

Digital control

VW1 has two digital signals that provide a simple on/off and monitoring interface.

PON Input Signal

ON is an active-low digital input signal with 3.3V logic-levels. Asserting PON to a logic-low will turn ON the output of the supply independently of the On/Off push button. An internal pull-up resistor keeps PON normally at a logic-high level.

For systems that require always-on power, PON can be wired to GND (-) directly or through a switch or relay contact.

Alternatively ON can be controlled by an external digital signal. The Specification section of this document details the logic threshold levels.

POK Output Signal

OK is an active-high digital output signal with 3.3V logic-levels. A logic-high output indicates the VW1 power output is on and valid. A logic-low output indicates output power is off and/or there is a fault.

Slew-rate Configuration

VW1 provides a controlled turn-on slew rate for main output terminals. Refer to the *Specifications* section of this document for slew-rate characteristics. Turn-off slew rate is not controlled and is a function of the load current and load capacitance.

Slew-rate can be decreased by connecting a capacitor between the SLEW terminal and GND (-). The slew rate is calculated as follows:

$$\text{Slew Rate} = \frac{33\mu\text{A}}{C_{\text{slew}}} \text{ [V/s]}$$

The slew-rate can be decreased from the default value but it cannot be increased.

Operation

VW1 uses a linear regulation system consisting of a regulator controller and a discrete MOSFET as the series power control. In normal operation the regulator is always enabled. The regulator is directly adjusted by the voltage adjust trimmer. The MCU's main tasks are supervising system operation, monitoring voltage and current and displaying information on the readouts.

The micro USB connector is for USB-style power only and is not a USB control interface.

Most applications should use the main output terminals to allow VW1 to switch output power on and off. The main output provides controlled slew rate, fault handling, and short-circuit protection. In some specialized applications, the voltage drop across the output switch might be a consideration. The "R" terminal allows direct connection to the regulator, but without the benefits of the main output switch, such as slew-rate control.

Note that the VW1 output switch has an internal resistance of just 0.0025 Ohms (typical), so in most applications the voltage drop will be less than the wire connections. Therefore the main terminals provide satisfactory performance.

Mechanical outline

Dimensions are in millimeters.

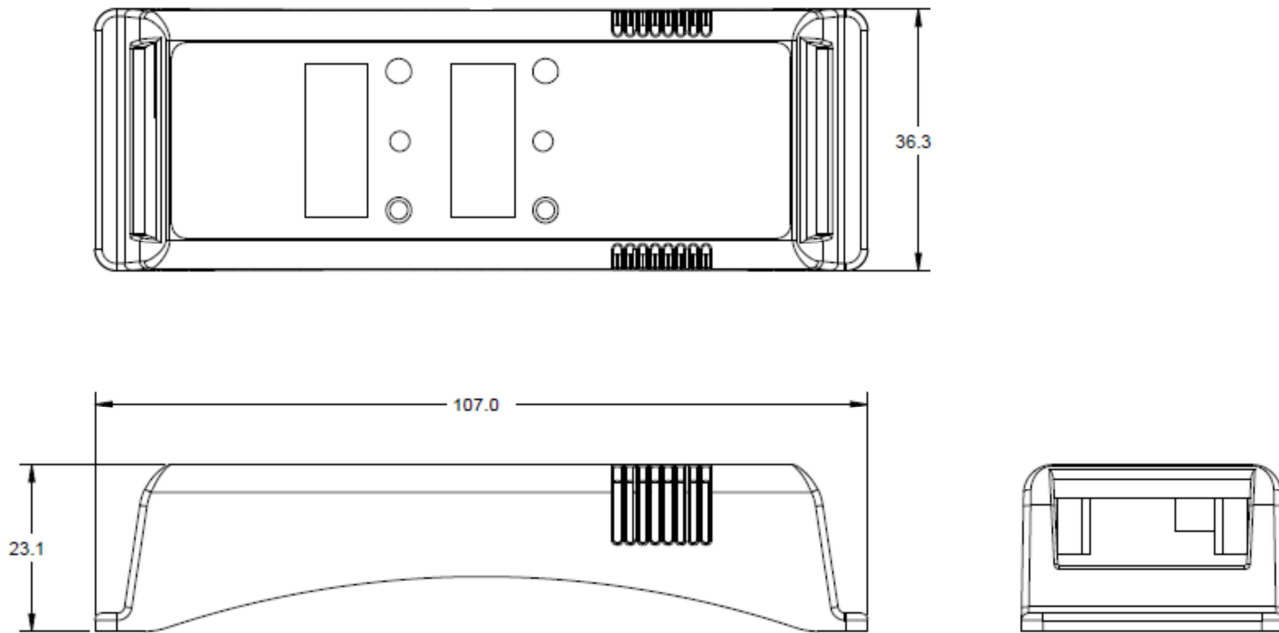

Mounting options

VW1 has two tapped (4-40) mounting holes on the back of the enclosure. The holes can be used directly for in-system mounting, or used with a DIN-rail mounting clip (Winford DINM12-RC).

Screws must not extend more than 1/8" into the VW1 unit. Excessively long screws may cause permanent damage.

Mounting drawing

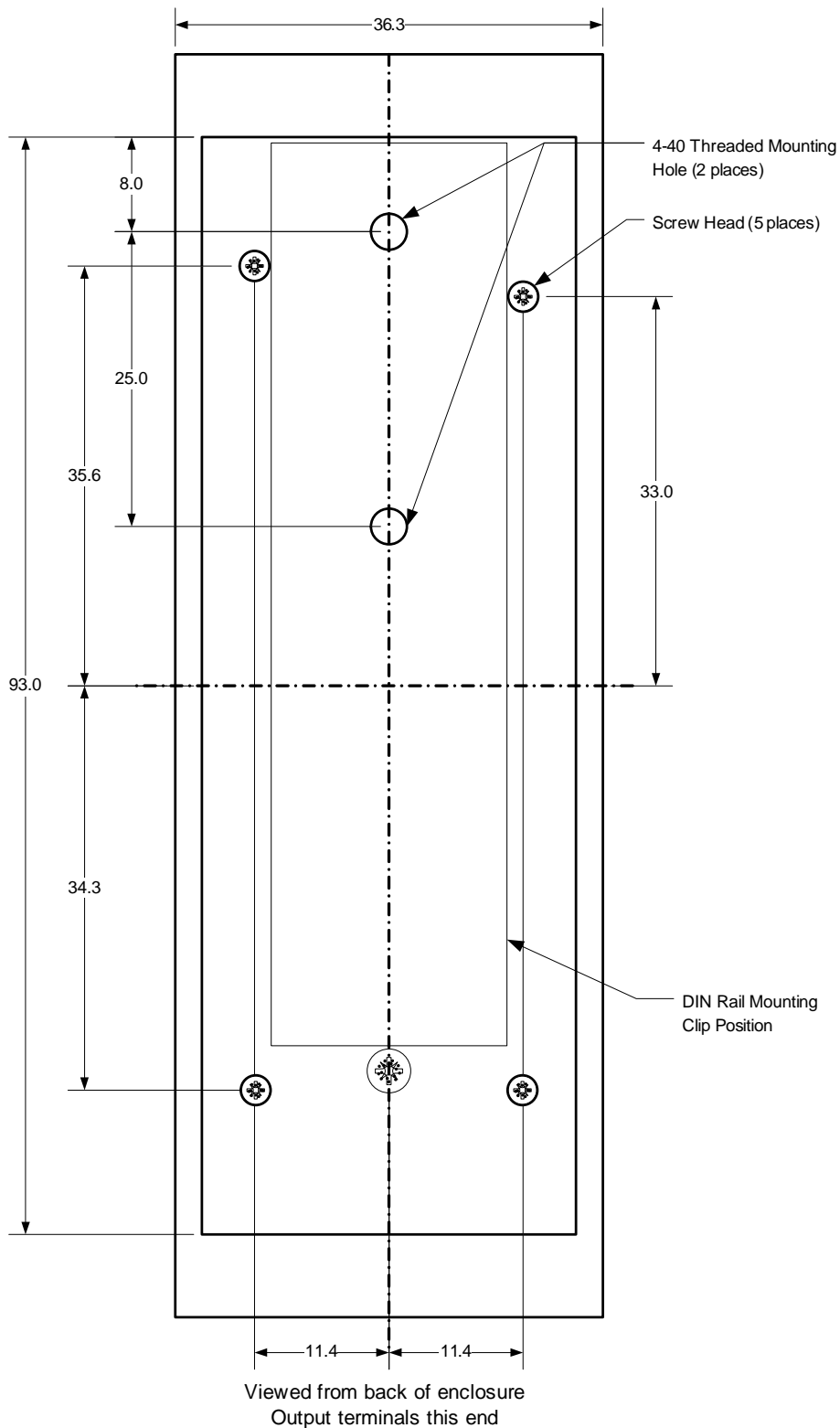

VW1 Power Supply Specifications

Characteristics

Parameter	Min	Typ.	Max	Unit
Output voltage range (using 5V power source)	0.8		4.5	V
Output voltage range (using 12V or greater power source)	0.8		10.2	V
Output current			2	A
Input supply voltage range	4.5		16	V
Internal Power dissipation (25°C ambient) $P = (V_{in} - V_{out}) * I_{load}$			4	W
Drop-out voltage @ 1A load		0.2		V
Quiescent current with output on		22		mA
Quiescent current with output off		16		mA
Output noise with 2V 2A load (wall supply)		< 0.5		mV p-p
Output ripple with 2V 2A load (wall supply)		1		mV p-p
Output noise with 10V 1A load (wall supply)		< 0.7		mV p-p
Output ripple with 10V 1A load (wall supply)		2		mV p-p
Voltage adjustment accuracy		5		mV
Voltage measurement accuracy - full range (calibrated)		10		+/-mV
Voltage measurement accuracy over Vout 20-75% (calibrated)		5		+/- mV
Current measurement accuracy up to 1.5A (calibrated)		3		+/- mA
Operating temperature range (max - see table for SOA)	0		50	°C
Current trip range	0.01		2.2	A
Current trip speed (time to shutdown at 100% of Itrip)		tbd		
POK open-drain active output voltage @ 1mA	0		0.6	V
Power OK internal pull-up resistance (to 3.3V)		10.2		kΩ
PON input Vil (threshold to turn-on)		0.45		V
PON input Vih (threshold to turn-off)		1.7		V

Fault Limits

Parameter	Min	Typ.	Max	Unit
Input supply under-voltage fault		4.5		V
Input supply over-voltage fault		21		V
Drop-out voltage (Vin - Vout) fault		0.2		V
Output voltage maximum voltage fault		10.6		V
Heatsink Temperature fault		70		°C

Current trip fault (user adjustable range)	0.01	2.2	A
--	------	-----	---

Absolute Maximum Ratings (1)

Parameter	Value	Unit
Input voltage (continuous)	18	V
Input voltage (surge for 1 second)	24	V
Reverse input voltage (continuous)	-0.6	V
Reverse input current (surge for 1 second)	4	A
PGD/PON input voltage	6	V
PGD/PON/SLEW ESD rating (HBM)	16	kV
Power in/out ESD rating (HBM)	16	kV
Ambient or storage operating temperature range	70	°C

(1) Stresses above these ratings may cause permanent damage

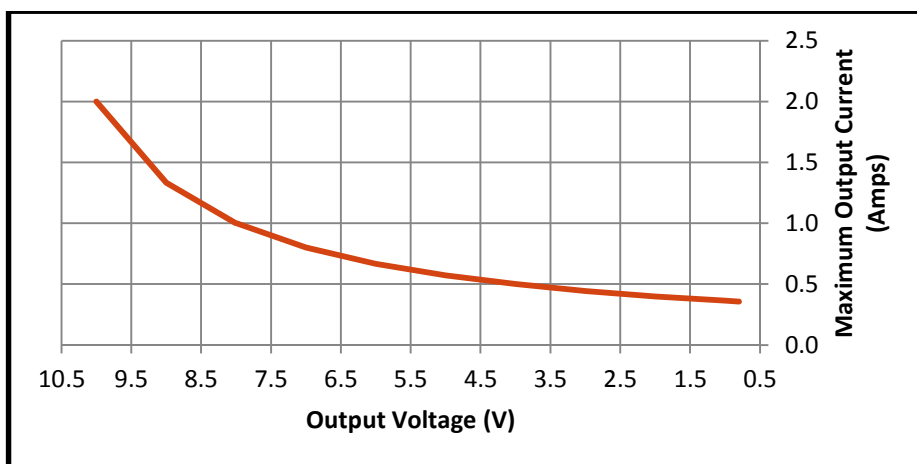
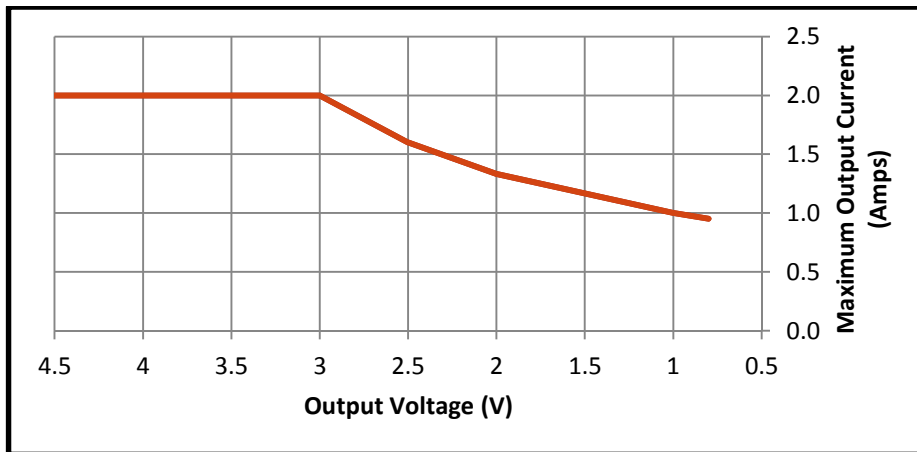

Power Adapter Specifications

Part Number VW-M1-5V

Specification summary for the included wall adapter:

- Input voltage range AC 100 – 240VAC
- Input Frequency 50 – 60Hz
- Output voltage 5.0V +- 5% @ 10W
- Compliance: RoHS, CEC Level V, UL/cUL

For additional information on this Wall Adapter refer to the Volgen KTPS10 Series datasheet.

Part Number VW-M1-12V-US, VW-M1-12V-EU, and VW-M1-12V-UK

Specification summary for the included wall adapter:

- Input voltage range AC 100 – 240VAC
- Input Frequency 50 – 60Hz
- Output voltage 12.0V +- 5% @ 12W
- Compliance US model: RoHS, CEC Level V, UL/cUL
- Compliance EU and UK Model: RoHS, CEC Level V , EN 60950-1, CE. EMI/EMC EN 55022 Class B, AS/NZS CISPR 22 Class B, EN 61000-3-(2,3), IEC 61000-4-(2,3,4,5,6,8,11)

For additional information on this Wall Adapter refer to the relevant CUI EPSA 12V Series datasheet.

Calibration

The voltage and current measurement capabilities of VW1 are factory calibrated. Refer to the electrical characteristics section for calibration limits. While calibration guarantees the maximum limits for 1 year, more frequent calibration will provide improved accuracy. The calibration procedure is very simple.

Volts Calibration

The voltage calibration procedure is:

1. Connect a calibrated DVM to the output terminals of VW1. Accuracy of the DVM should be better than +/-1mV when measuring $5V_{DC}$.
2. Press the On/Off button to turn-on the power supply output (green LED is on).
3. Adjust VW1 voltage output until DVM reads 4.500V +/- 2mV
4. Press and hold the On/Off button for 6 seconds.
5. Output power will cycle off then on. The volts display will now read 4.500V

Voltage measurement calibration is now complete.

Amps Calibration

The amps measurement calibration procedure is a two-step process. First, the offset is calibrated with the power off, and then the gain is calibrated with a known load current.

Offset calibration

1. If necessary, press the On/Off button to turn-off the power supply output (green LED is off).
2. Press and hold the MODE button for 6 seconds.
3. After 6 seconds the Amps display will read 0.000A.

Gain calibration

4. Connect a resistive load and calibrated Ammeter in series on the output terminals of VW1. Accuracy of the Ammeter should be better than +/-1mA when measuring 0.5A_{DC}. The resistor value is not critical but a value around 10Ω with a 5W or higher power rating is recommended.
5. If necessary, press the On/Off button to turn-on the power supply output (green LED is on).
6. Adjust VW1 voltage output until Ammeter reads 400mA +/- 1mA.
7. Press and hold the MODE button for 6 seconds.
8. After 6 seconds the Amps display will read 0.400A.

Amp measurement calibration is now complete.

Self-test

VW1 has an internal self-test procedure that validates internal functionality. A 5V power supply and a 10-ohm +/- 5% resistive load must be attached before initiating the test. Testing must be done with the VW1 at or close to room temperature since the test is used to calibrate the internal temperature sensor.

The limits for this test are fairly wide since calibration may not be valid at this stage

Start with the input supply power turned-off. Hold down both push buttons while applying 5V power. The self-test sequence will run automatically as follows:

- 1) Count 0..F on each LCD digits on all displays. This is a manual test to observe LCD segment operation. No fault codes will be reported.
- 2) The test sequence starts with the power off. Then it confirms that load current is close to zero. The amps LCD reports Fault 1 if load current reading is not less than 10 mA.
- 3) Check input supply voltage is close to 5V. If supply voltage measures less than 4.90V then Fault 2 is reported. If the supply voltage is high than 5.45V then Fault 3 is reported.
- 4) Check regulator output voltage is greater than 0.8V. If too low then report Fault 4.
- 5) Check that output terminal voltage is close to zero. Report Fault 5 if the reading is greater than 13mV.
- 6) The test sequence now turns on the output switch then checks that output voltage is close to the regulator voltage. The actual level is not critical. Difference between voltages must be less than or equal to 30mV or a Fault 6 is reported.
- 7) Confirm that measured current is correct for a 10 ohm load. The measured current must be within 60mA of calculated current. If the measured current is too low then Fault 7 will be reported. If the measured current is too then Fault 8 is reported.
- 8) Check temperature reading and use the value for temperature sensor offset calibration. Calibration data is automatically stored in non-volatile memory if this test passes. If the temperature reading exceeds the expected range of values then report Fault 9.

If any test in the sequence fails, addition test steps will halt and the fault code is displayed on the Amps display. If all 9 steps pass, then a "PASS" message is displayed. A power cycle is needed to resume normal operation.

Compliance Information

This device complies with Part 15 of the FCC Rules as an exempt test equipment device intended for use in a professional environment. Operation is subject to the following two conditions: (1) this device may not cause harmful interference, and (2) this device must accept any interference received, including interference that may cause undesired operation.